





Phone: (314) 644-4300, Fax: (314) 644-5332
www.indeeco.com

INSTRUCTIONS UHCI Series (10.1 kW to 20 kW)



WARNING



When using electrical appliances, basic precautions should always be taken to reduce the risk of fire, electrical shock and injury, including the following:

Read carefully these instructions before installation, operation of the heater. Failure to adhere to the instructions could result in fire, electric shock, serious personal injury, and death or property damage. Review frequently for continuing safe operation and instruction of future users, if necessary.

IMPORTANT INSTRUCTIONS

- Read all instructions before installing or using this heater.
- This heater is hot when in use. To avoid burns, do not let bare skin touch hot surfaces. Keep combustible materials, like furniture, pillows, bedding, papers, clothes, and curtains at least 36 in. (915 mm) from the front of the heater and away from the sides and rear.
- Extreme caution is necessary when any heater is used by or near children or invalids and whenever the heater is left operating and unattended.
- Do not operate any heater after it malfunctions. Disconnect power at service panel and have heater inspected by a reputable electrician before reusing.
- To disconnect heater, turn off power to heater circuit at main disconnect panel.
- Do not use outdoors.
- Do not insert or allow foreign objects to enter any ventilation or exhaust opening as this may cause an electrical shock or fire, or damage the heater.
- To prevent a possible fire, do not block air intakes or exhaust in any way whatsoever.
- A heater has hot and arcing or sparking parts inside. Do not use it in areas where gasoline, paint or flammable liquids are used or stored.
- Use this heater only as described in this manual. Any other use not recommended by the manufacturer may cause fire, electrical shock, or injury.
- The thermostat should not be considered an infallible device in cases where maintaining a temperature is considered critical. In these particular cases, it is imperative to add a monitoring system to avoid the consequences of a thermostat failure.
- This heater is not approved for use in corrosive atmospheres, wet or very humid locations such as marine, green house or chemical storage areas.

SAVE THESE INSTRUCTIONS

OPERATING INSTRUCTIONS

The heater must be properly installed before it is used.

HEATER OPERATION

Start up

On a call for heat from either the remote thermostat or the unit mounted thermostat the elements and fan will be energized.

When the thermostat is satisfied the elements will be deenergized.

The fan will continue to run until the residual heat is removed from the heater. Then the fan will stop.

Automatic Reset Thermal High Limit

The heater has an automatic reset thermal high limit that will deenergize the heating elements if the interior temperatures of heater exceed its setting. The limit will automatically reset when the heater interior temperatures fall below its setting.

MAINTENANCE INSTRUCTIONS

The heater motor is permanently lubricated.

Occasional cleaning of the inlet grille will prevent clogging. Use a vacuum with a brush attachment.

Cleaning should be done while the heater is disconnected from the main service panel. Wait until the housing and heating elements cool before performing maintenance.

Any other servicing should be performed by a qualified technician.

INSTALLATION INSTRUCTIONS

- All wiring must be in accordance with National and Local Electrical Codes.
- Heater must be grounded as a precaution against possible shock.
- To avoid possible electrical shock, disconnect all power at the main panel prior to wiring.
- Verify the power supply voltage coming to the heater matches the heater nameplate rating (on back of heater) before energizing heater.
- When installed, heater must be electrically grounded in accordance with the National Electrical Code.
- See **Figures 1 & 3** and **Tables 1 & 3** for minimum mounting clearances.

CAUTION

- Use only with copper branch circuit conductors.
- Use supply wires suitable for 90 °C (194 °F)
- Minimum mounting height: 6 ft. (1.8 m) in USA and 8 ft. (2.4 m) in Canada.
- High temperature, risk of fire, keep electrical cords, drapery, furnishings, and other combustibles at least 36 in. (915 mm) from the front of the heater and away from the sides and rear.
- To reduce the risk of fire, do not store or use gasoline or other flammable vapors and liquids in the vicinity of the heater.
- To prevent possible overheating - or damage due to overheating - keep at least 5 ft. (1524 mm) clearance in front of heater.
- See **Tables 1 & 3** for side, ceiling and back minimum mounting clearances.
- Wall/Ceiling structures and anchoring must be sufficient strength to support the combined weight of the heater and mounting bracket. See **Table 5**.

LOCATE THE HEATER PROPERLY

The heater may be mounted for either horizontal or vertical heated air discharge.

Note: Install accessories in accordance with their installation instructions prior to mounting heater.

HEATER INSTALLATION

Horizontal Air Discharge Mounting

Use manufacturer supplied brackets for wall or ceiling installation or use 4 threaded rods (not supplied).

See **Figure 2** and **Table 2** for threaded rod size and spacing.

Note: The bracket to be fixed on the heater can be supplied in 2 pieces. Here's how to assemble them.

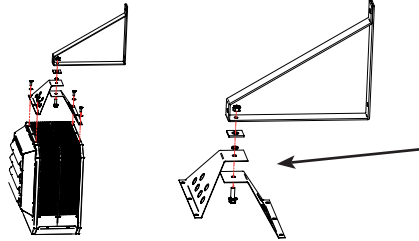

Vertical Air Discharge Mounting

Threaded rod (not supplied) must be used. See **Figure 4** and **Table 4** for threaded rod size and spacing.

If heater is mounted with control compartment toward wall insure that heater is mounted with enough clearance to the wall (minimum = width of heater) to allow the control compartment access door to open.

WIRING

All wiring must be in accordance with National and Local Electrical Codes.

The heater must be grounded as a precaution against possible shock.

Insure power source is deenergized before wiring heater.

Check nameplate on back of heater.

Connect heater only to voltage and phase specified on nameplate.

Two knock-outs are provided in the back of the heater:

- **For supply power wiring:**
Use a multiple 1 3/8 in. to 1 3/4 in. (35 mm to 44 mm) knock-out.
- **For control wiring:**
Use a 1/2 in. (13 mm) knock-out.

Field wiring must be properly sized to carry the amperage of the heater and all accessories.

The heater has a wiring diagram affixed to the inside of the control compartment access door. Check this diagram before making any electrical connections.

Wiring compartment volume:
85 in.³ (1393 cm³) minimum.

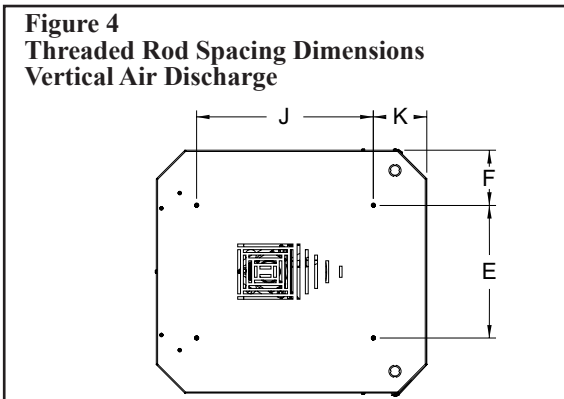
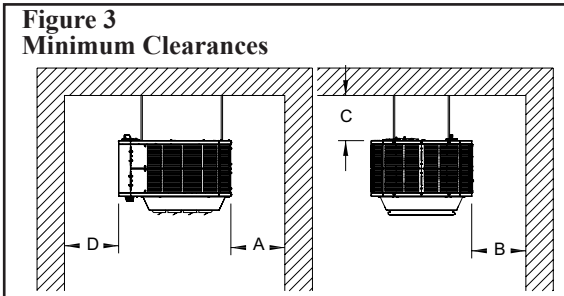
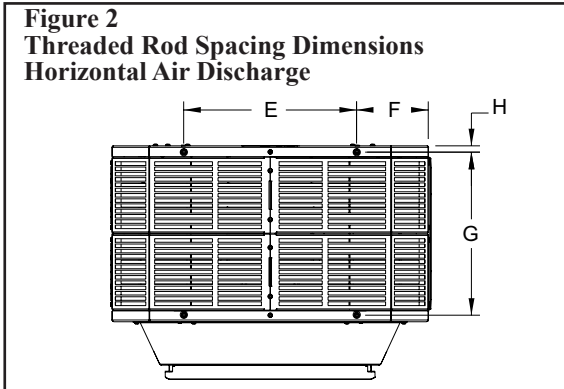
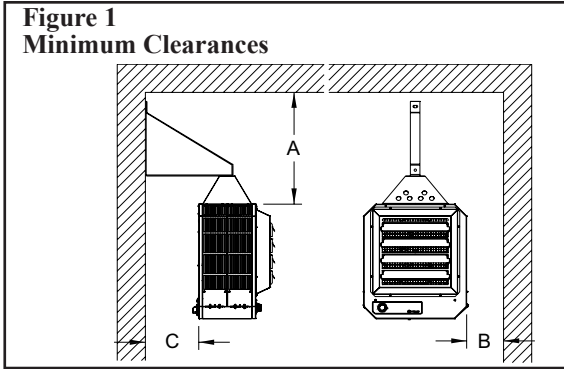

| Heater kW | Discharge Air | A Ceiling | B Side | C Back |
|-----------------|---------------|-----------------|-----------------|-----------------|
| 10.1 to 20.0 kW | Horizontal | 6 in. 152 mm | 6 in. 152 mm | 6 in. 152 mm |

| Heater kW | Threaded Rod | E | F | G | H |
|-----------------|--------------|---------------------|---------------------|-----------------------|-------------------|
| 10.1 to 20.0 kW | 3/8 - 16 | 6 1/2 in. 165 mm | 4 1/2 in. 114 mm | 11 5/16 in. 287 mm | 7/16 in. 11 mm |

| Heater kW | Discharge Air | A Wall | B Wall | C Ceiling | D Wall |
|-----------------|---------------|------------------|------------------|-----------------|-----------------|
| 10.1 to 20.0 kW | Vertical | 10 in. 254 mm | 10 in. 254 mm | 6 in. 152 mm | Width of heater |

| Heater kW | Threaded Rod | E | F | J | K |
|-----------------|--------------|------------------|-----------------|------------------|---------------------|
| 10.1 to 20.0 kW | 3/8 - 16 | 12 in. 305 mm | 5 in. 127 mm | 16 in. 406 mm | 4 3/4 in. 121 mm |

| Heater kW | Height | Width | Depth | Weight |
|-----------------|----------------------|------------------|----------------------|----------------|
| 10.1 to 20.0 kW | 24 1/2 in. 622 mm | 22 in. 559 mm | 16 1/4 in. 413 mm | 90 lb 41 kg |