

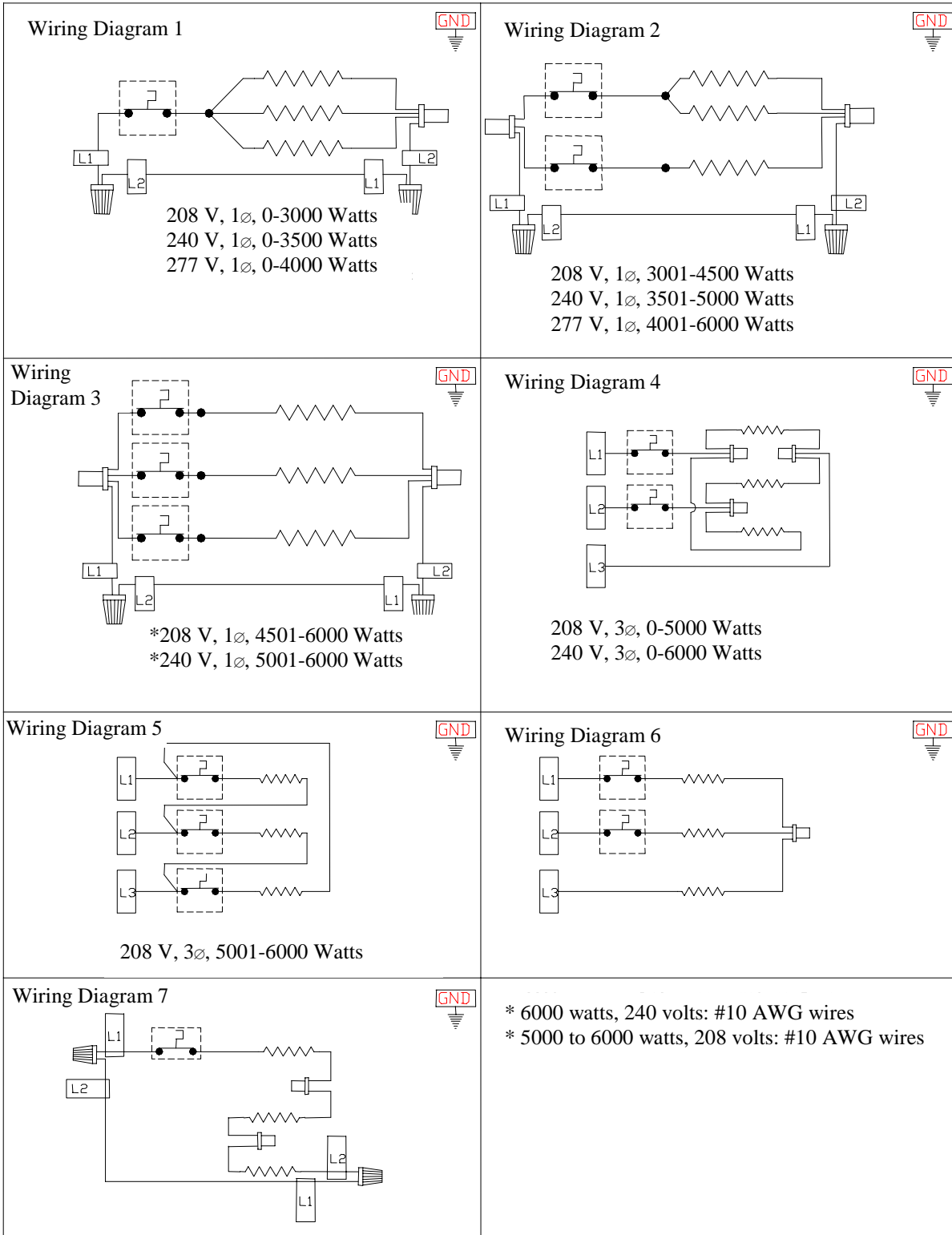

CAI/CASI WIRE DIAGRAM



INDEECO
425 Hanley Industrial Court • St. Louis, MO 63144
Phone: (314) 644-4300 Fax: (314) 644-5332
www.indeeco.com

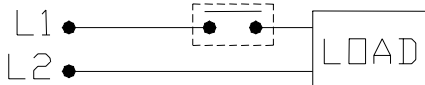
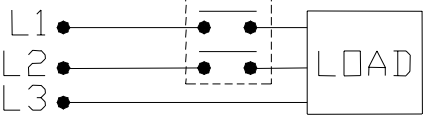
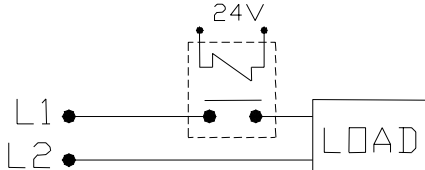
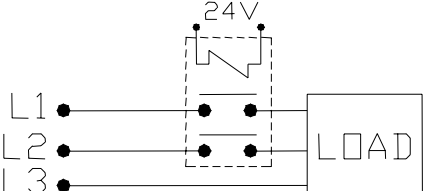
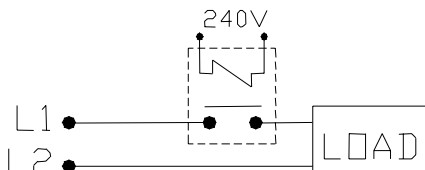
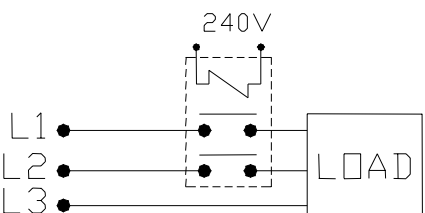
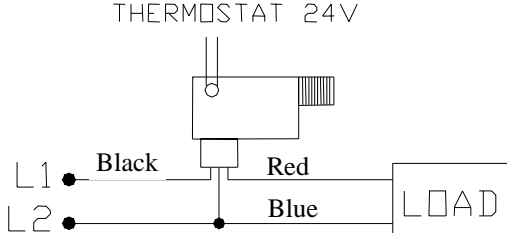
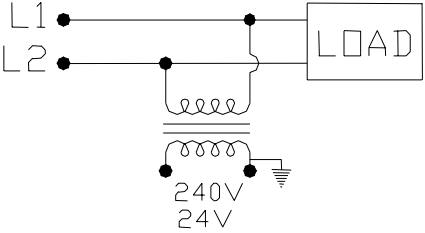

CAI/CASI WIRE DIAGRAMS - OPTIONS

| | |
|-------------------------------------------------------------------------------------------------------------------------------------------------------------------------|--------------------------------------------------------------------------------------------------------------------------------------------|
| <p>T1 - 30 AMPS 240 VOLTS 15 AMPS 600 VOLTS</p>  | <p>T2 - 30 AMPS 240 VOLTS 15 AMPS 600 VOLTS</p>  |
| <p>R1 - 5000 WATTS 208 VOLTS 6000 WATTS 240/277 VOLTS</p>  | <p>R3 - 25 AMPS 240 VOLTS 12.5 AMPS 600 VOLTS</p>  |
| <p>R4 - 25 AMPS 240 VOLTS 12.5 AMPS 600 VOLTS</p>  | <p>R5 - 25 AMPS 240 VOLTS 12.5 AMPS 600 VOLTS</p>  |
| <p>R2 - 5000 WATTS 208 VOLTS 6000 WATTS 240/277 VOLTS</p> <p>THERMOSTAT 24V</p>  | <p>X1 AND X2</p>  |

INDEECO
425 Hanley Industrial Court • St. Louis, MO 63144
Phone: (314) 644-4300 Fax: (314) 644-5332
www.indeeco.com